

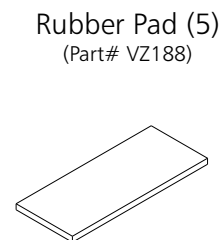

ASSEMBLY INSTRUCTIONS FOR 2B2 PORTABLE FUTSAL SOCCER GOAL

1. Unpack all parts and check for damage that may have occurred during shipping. If damage has occurred, notify trucking company immediately. Lay out all parts. Remove all cardboard and packaging immediately. Wet or damp packaging may damage contents.
2. Read through entire instruction before beginning assembly and installation.

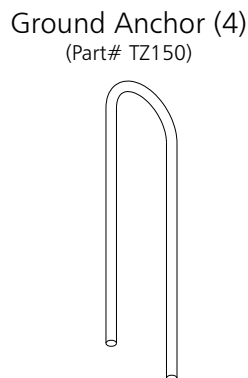
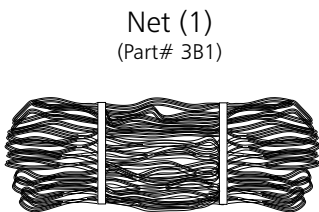
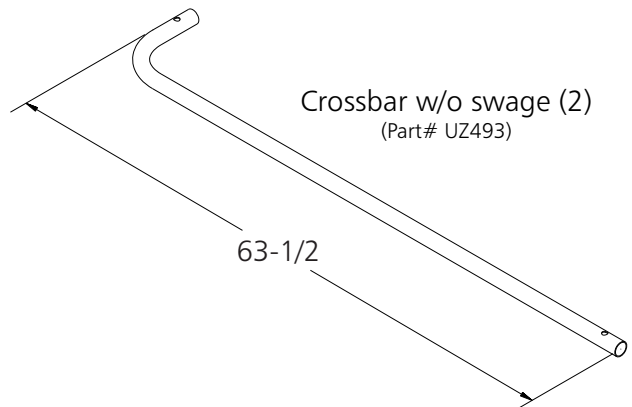
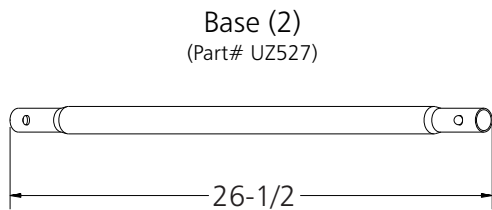
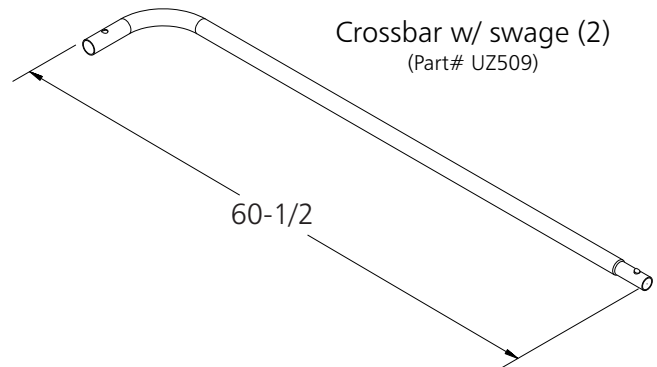
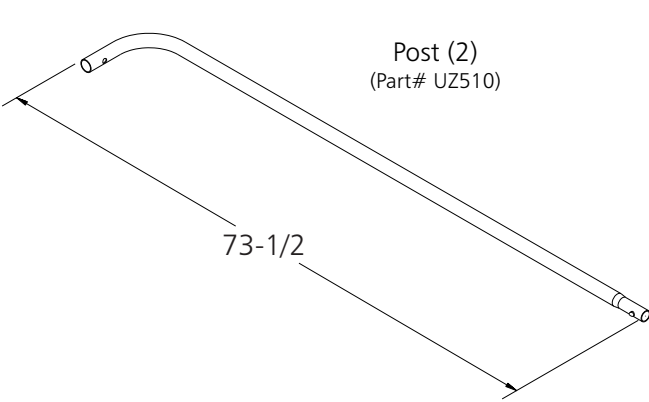

3. Assemble crossbars, base and post as shown.

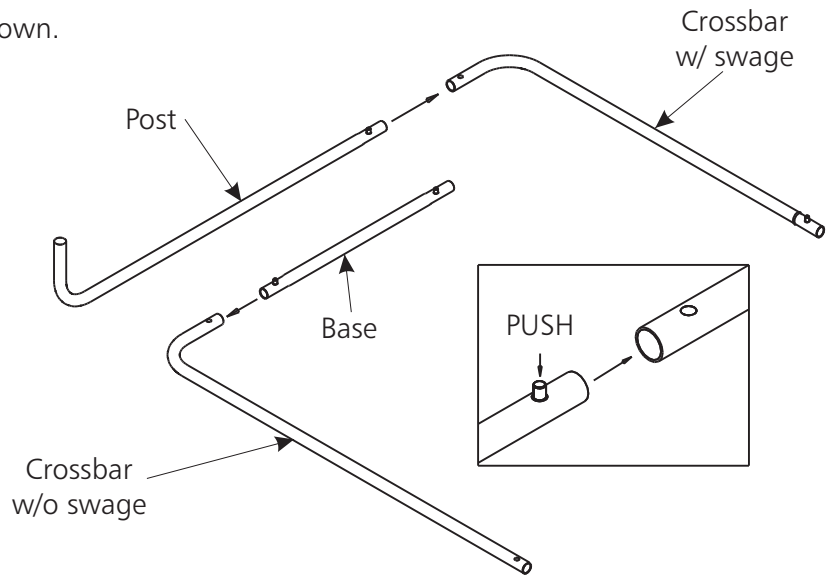

4. Weave assembled parts onto net as shown. Be sure to note the location of the top corner net tag.

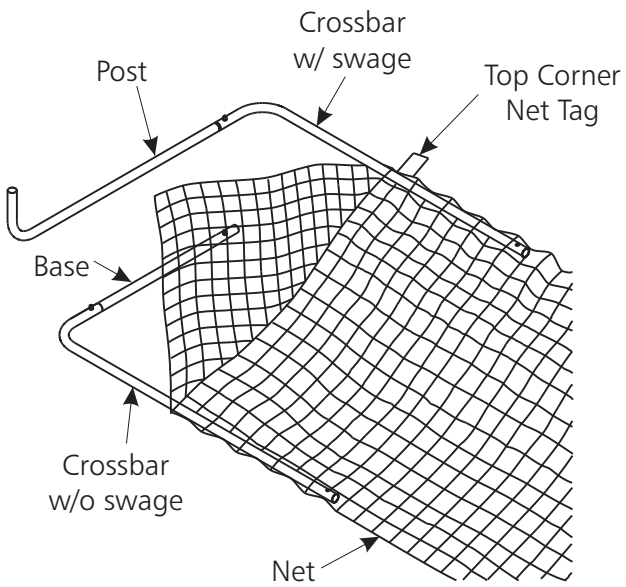

5. Connect crossbars, posts and bases as shown.

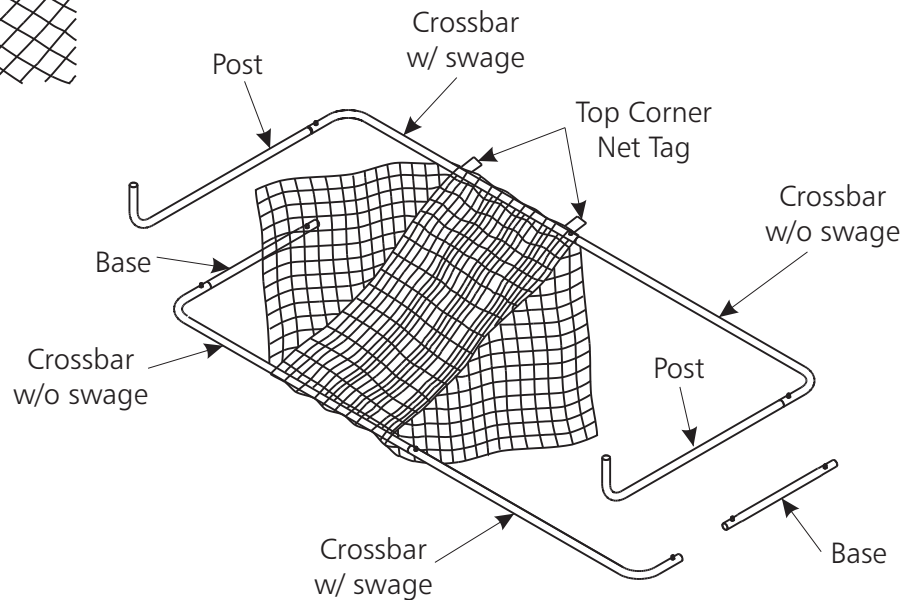

6. Weave base through net and attach to crossbar as shown.

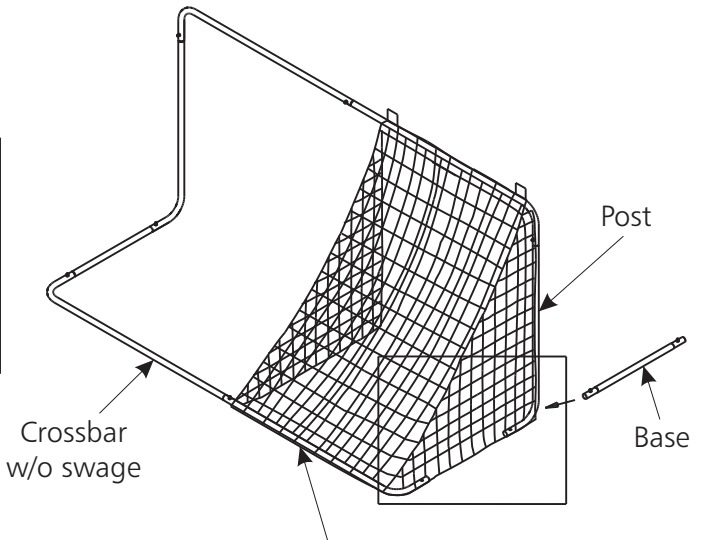
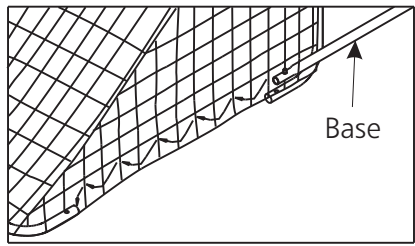

7. Disconnect post from goal and weave through net as shown. Reconnect post to base and crossbars as shown.

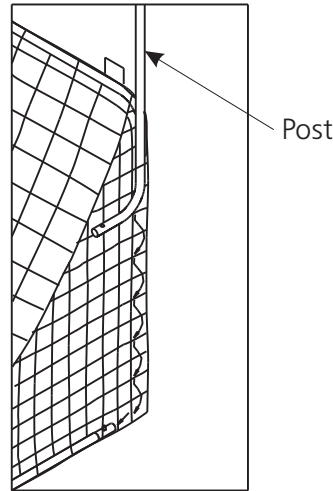
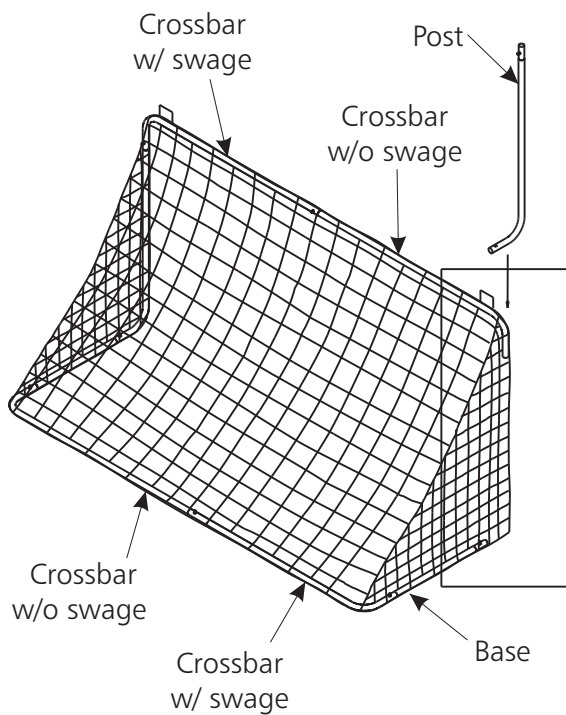

8. Repeat step 6 and 7 to attach net to opposite side of goal.

NOTE FOR INDOOR USE: Rubber pads can be added to bottom of goal by peeling off paper to expose adhesive. Place rubber pads on post and crossbars at locations shown.

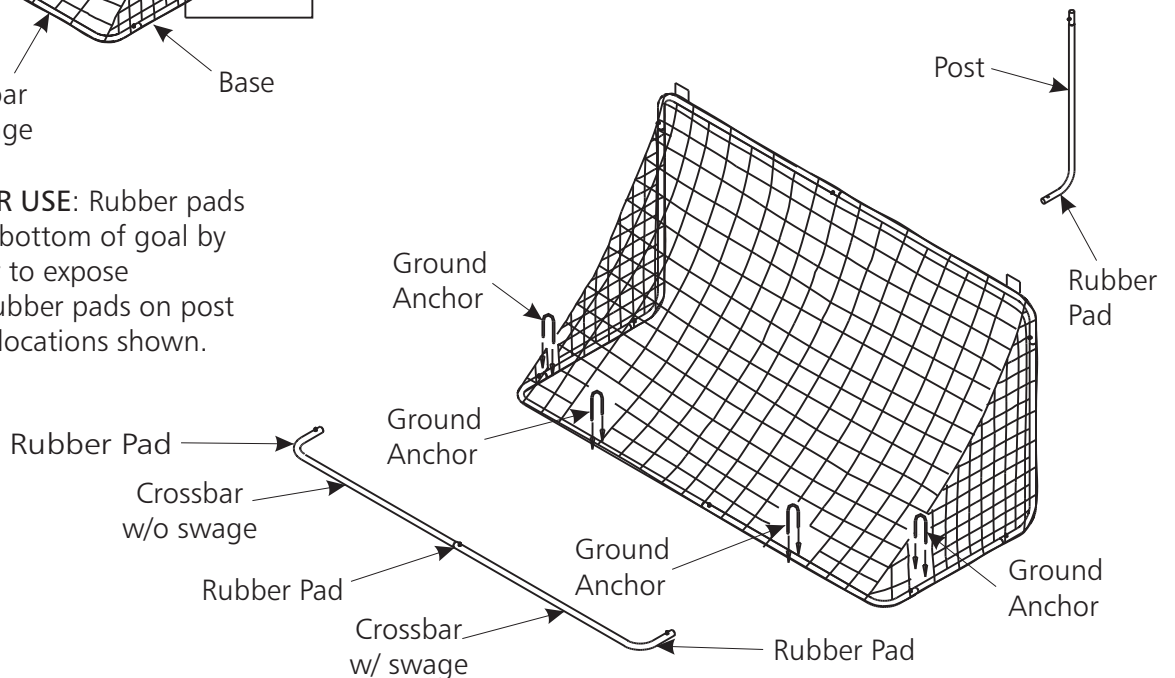

Go to Kwikgoal.com for additional product information.