

FRONT VIEW

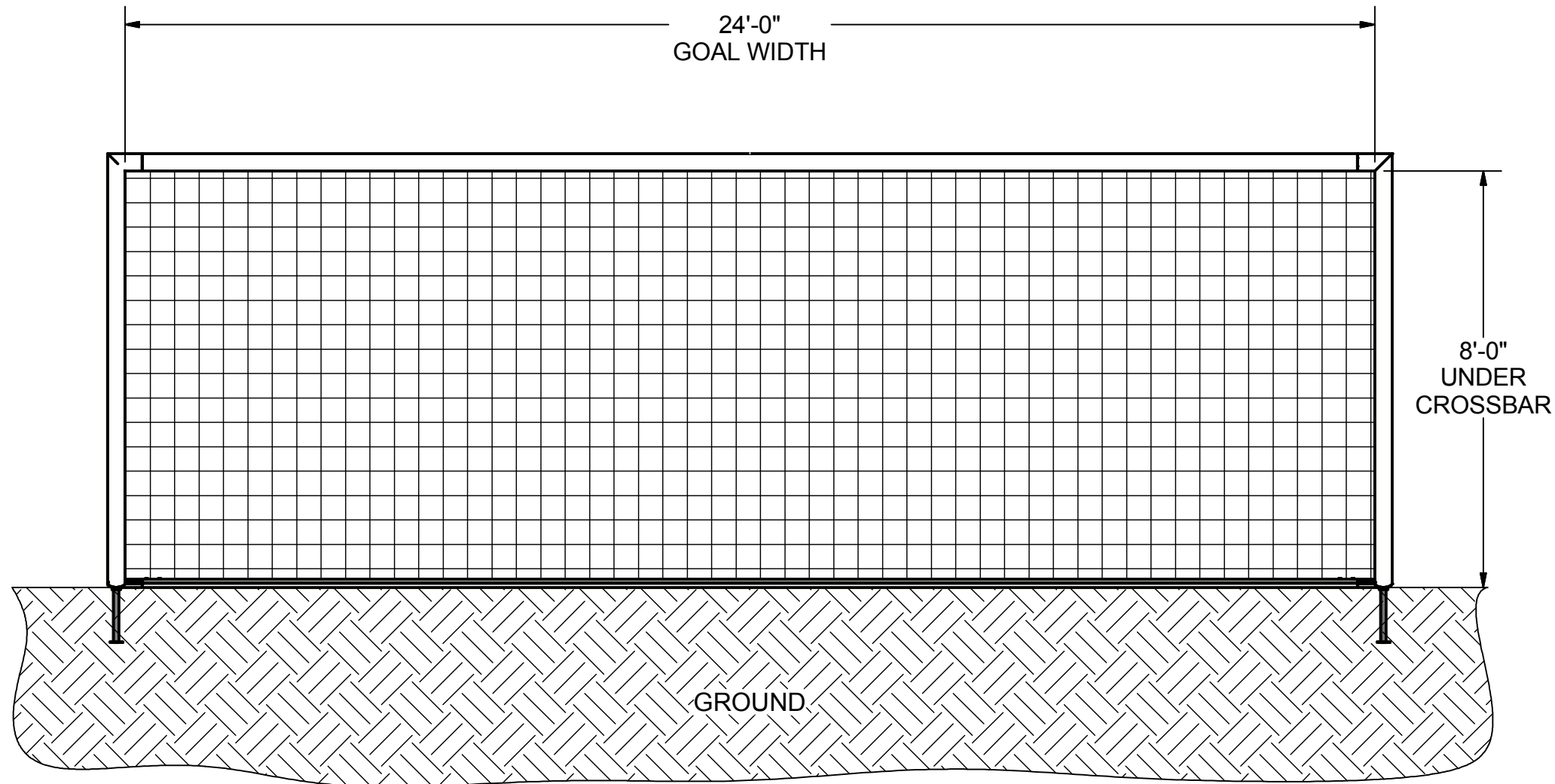

SIDE VIEW

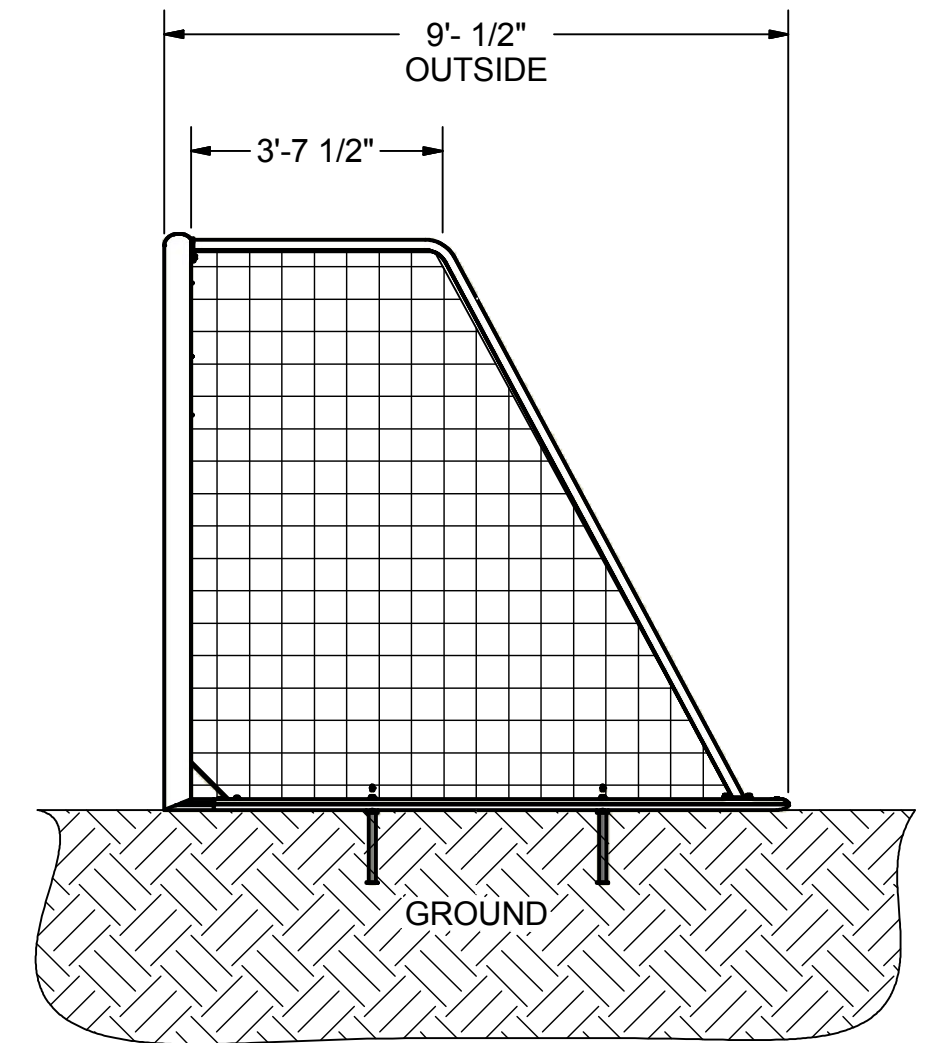

FEATURES:

- 1) ALUMINUM GOAL FRAME AND BACKDROPS
- 2) FINISH: WHITE POWDER COAT
- 3) INCLUDED:
 - SEMIPERMANENT GROUND ANCHORS
 - 3 mm, BLACK & WHITE NET
 - KWIK LOCK® NET CLIPS
- 4) ASSEMBLED GOAL WEIGHT: 185 LBS.
- 5) EXCEEDS:
 - NCAA SPECIFICATIONS
 - NFSHSA SPECIFICATIONS
 - ASTM F2950-14 STANDARDS

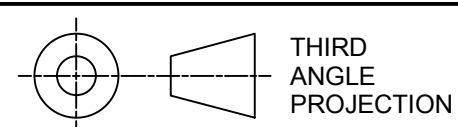

KWIKGOAL® 140 Pacific Drive
Quakertown,
Pa. 18951

DIMENSIONS ARE IN INCHES
UNLESS OTHERWISE SPECIFIED

Approved By:
Date:

Part #:
2B3306

This item is the **exclusive**
property of **KWIK GOAL LTD.**
Reproduction or duplication
without the express written
consent of **KWIK GOAL LTD.**
is **strictly forbidden.**

Drawn By: CSpeck
Date: 6/20/2003
Sheet: 1 of 4
Revision #: 10
Cad File: 2B3306.idw

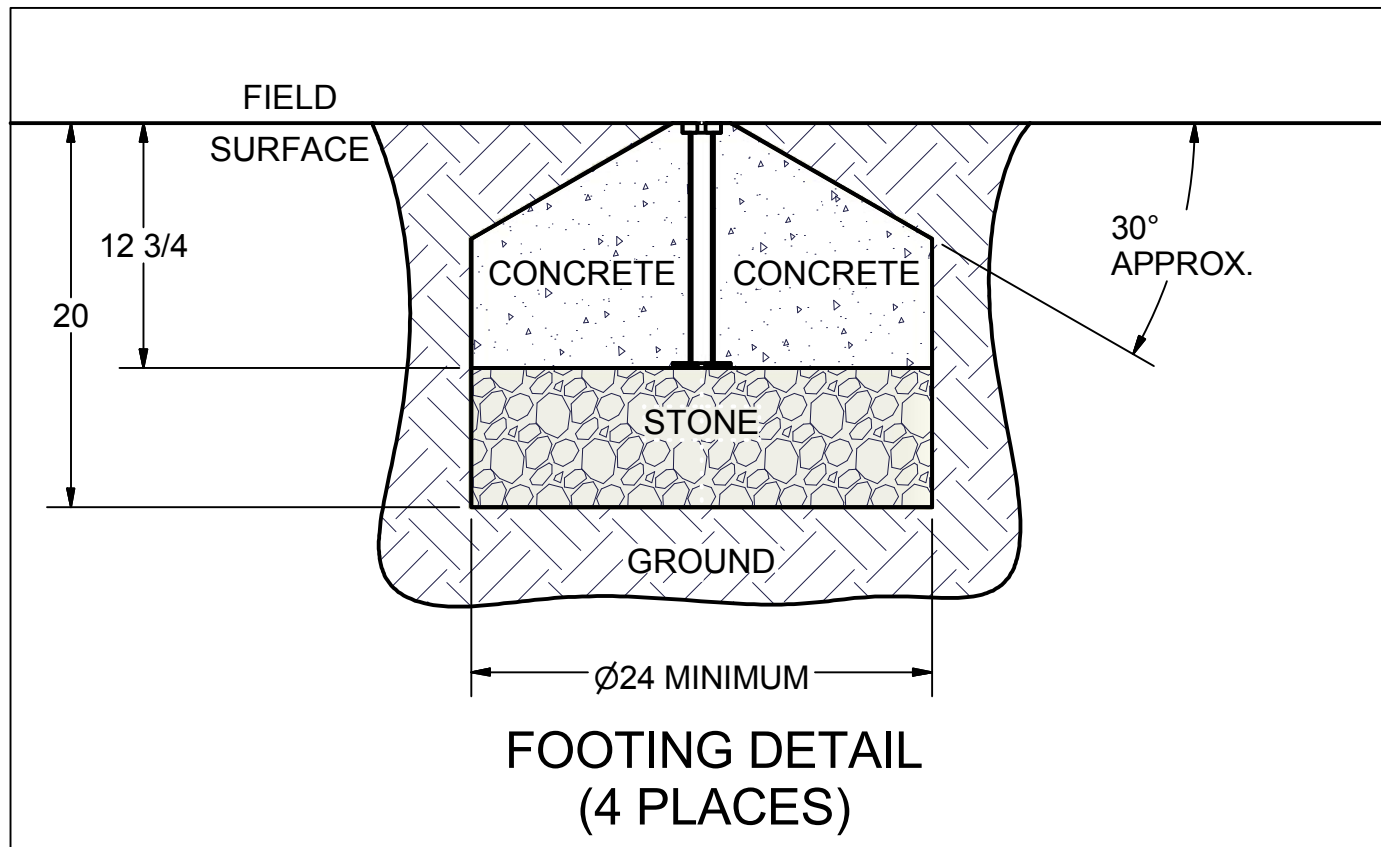
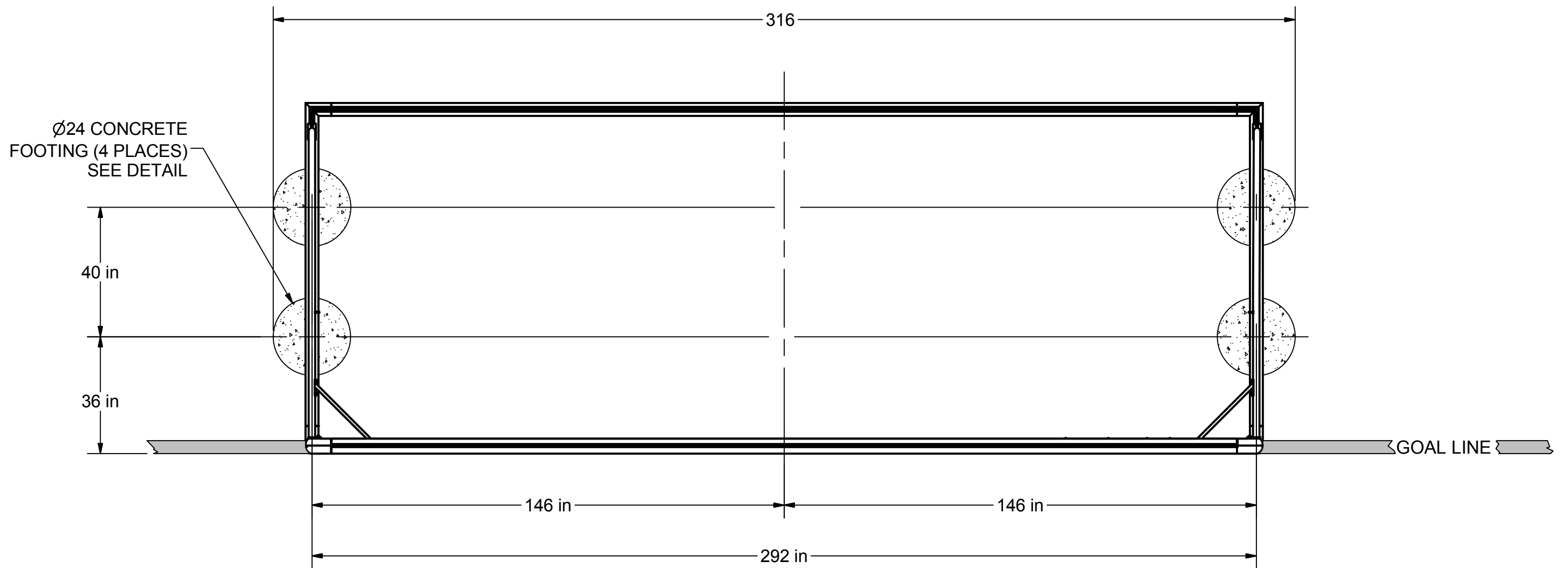

Desc:
8' x 24'
EVOLUTION 1.1 GOAL

OVERHEAD VIEW

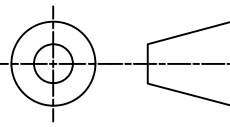

NOTES:

- 1) DIMENSIONS ARE FOR PLANNING PURPOSES. INSTALLATION MUST BE IN ACCORDANCE WITH INSTALLATION INSTRUCTIONS.
- 2) CUSTOMER SUPPLIED MATERIALS FOR GOAL INSTALLATION
 0.5 cubic yard - CONCRETE
 0.3 cubic yard - CLEAN STONE (1/4" - 3/4")
ABOVE AMOUNTS ARE PER GOAL INSTALLATION

 THIRD ANGLE PROJECTION	 140 Pacific Drive Quakertown, Pa. 18951	
	DIMENSIONS ARE IN INCHES UNLESS OTHERWISE SPECIFIED	Approved By: Date:
This item is the exclusive property of KWIK GOAL LTD. Reproduction or duplication without the express written consent of KWIK GOAL LTD. is strictly forbidden.	Drawn By: CSpeck Date: 6/20/2003	Desc: 8' x 24' EVOLUTION 1.1 GOAL
	Sheet: 2 of 4 Revision #: 10	
	Cad File: 2B3306.idw	

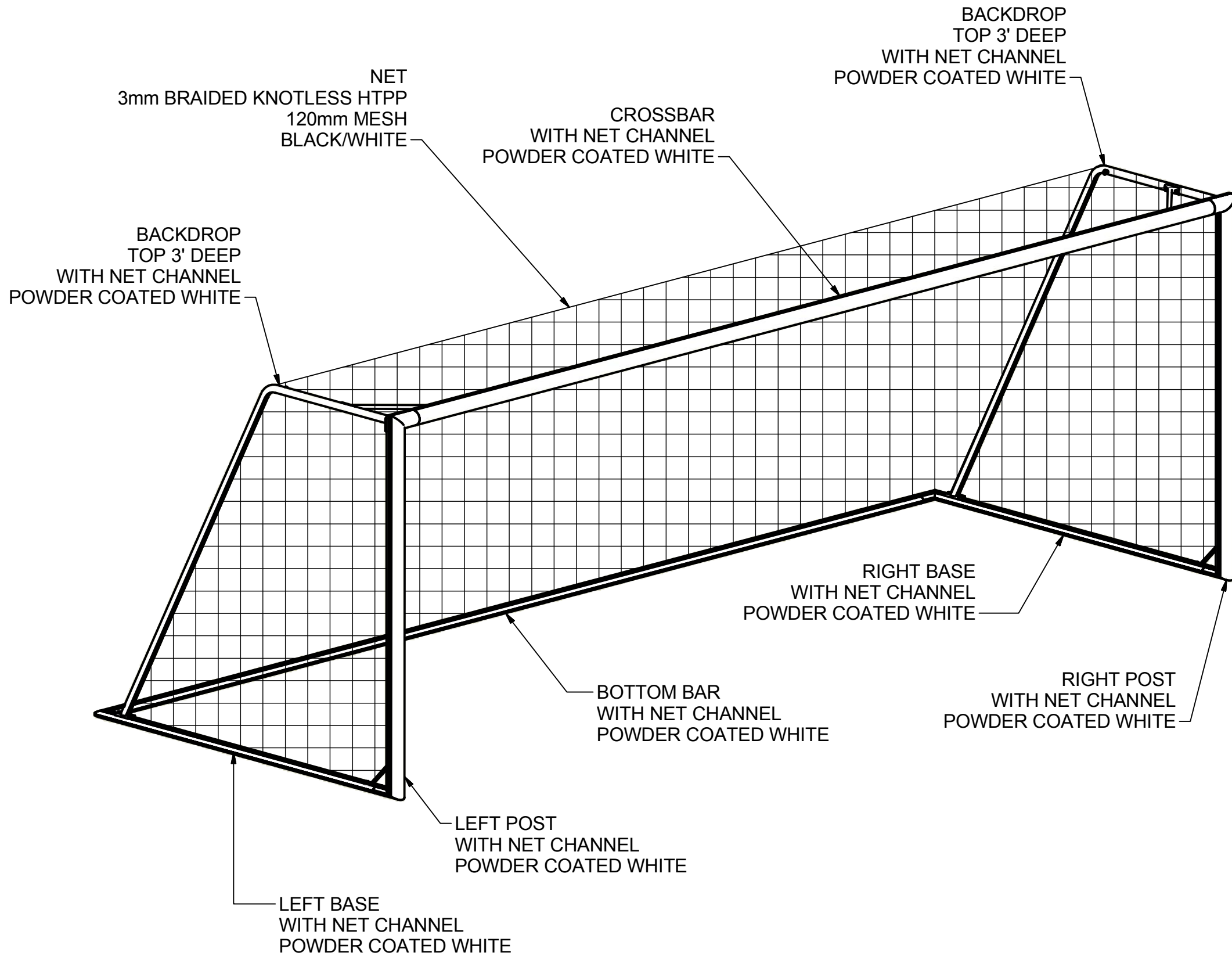

MATERIAL DETAILS

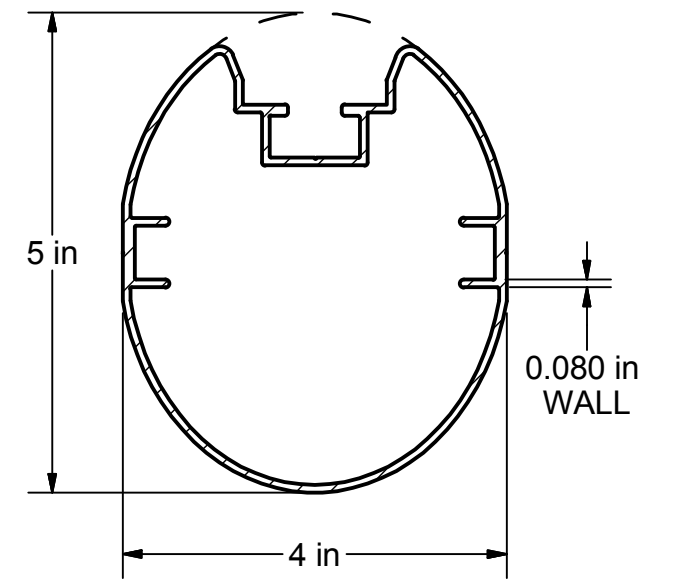

POSTS & CROSSBAR MATERIAL - ALUMINUM

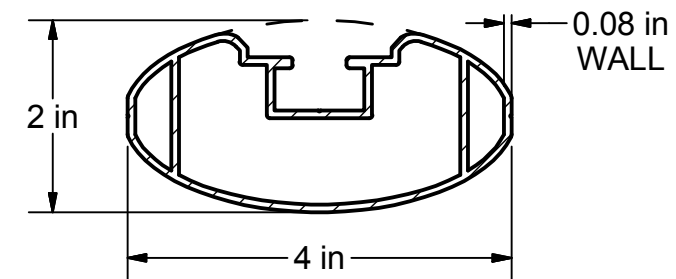

BOTTOM BAR & BASES MATERIAL - ALUMINUM

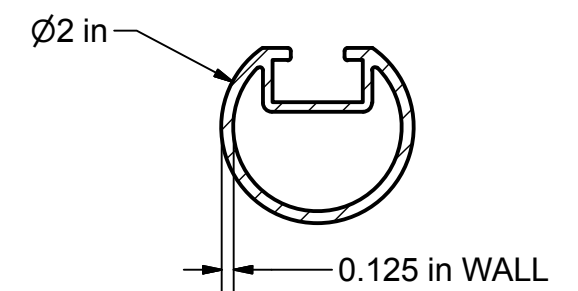

BACKDROP MATERIAL - ALUMINUM

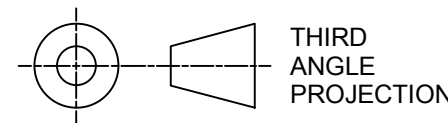

KWIKGOAL® 140 Pacific Drive
Quakertown, Pa. 18951

DIMENSIONS ARE IN INCHES UNLESS OTHERWISE SPECIFIED

Approved By:
Date:

Part #:
2B3306



This item is the **exclusive** property of **KWIK GOAL LTD.** Reproduction or duplication **without** the express written consent of **KWIK GOAL LTD.** is **strictly forbidden.**

Drawn By: CSpeck
Date: 6/20/2003
Sheet: 3 of 4
Revision #: 10
Cad File: 2B3306.idw

Desc:
8' x 24'
EVOLUTION 1.1 GOAL

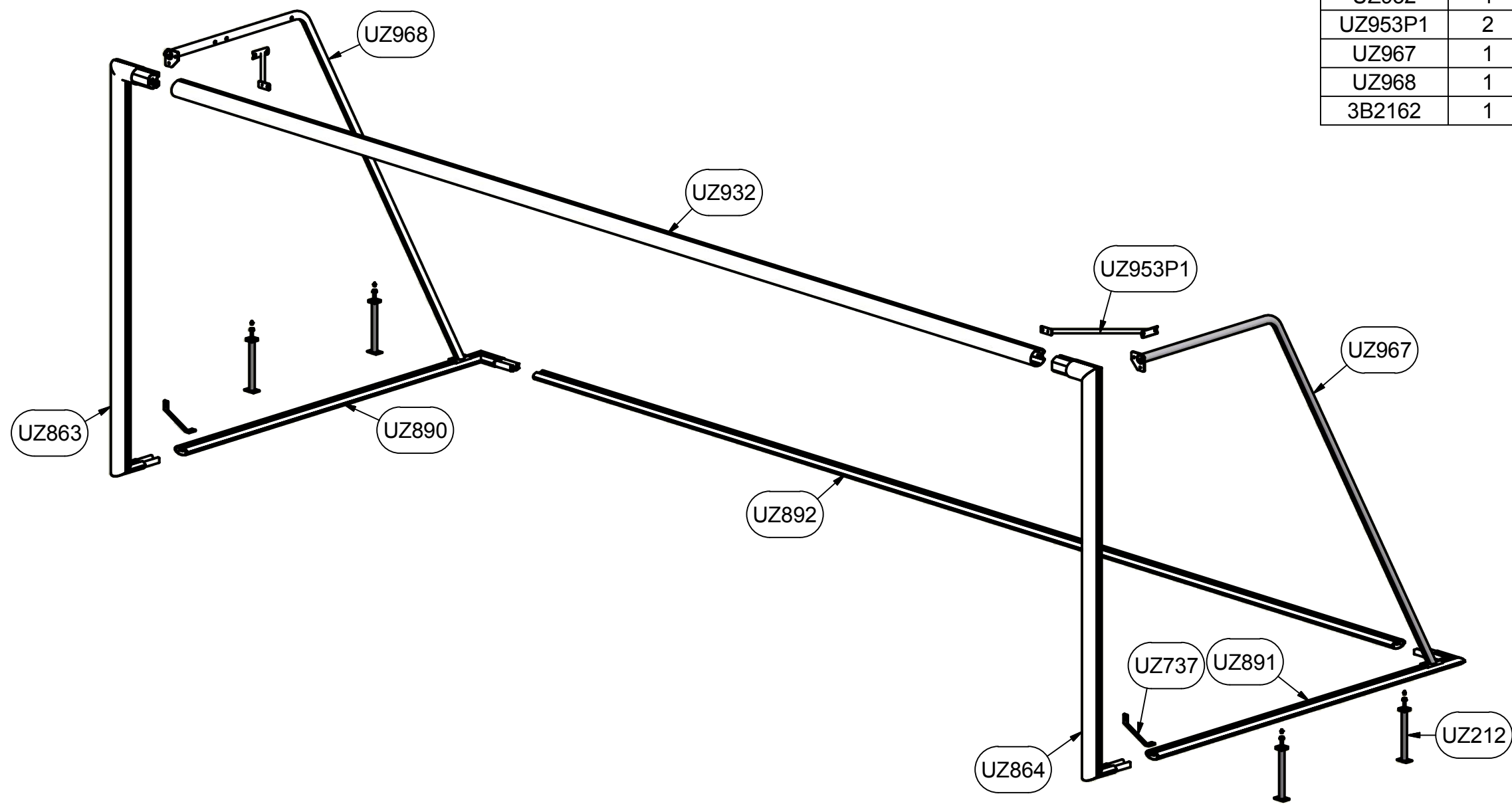
Parts List		
Part #	Qty	Description
UZ212	4	GROUND ANCHOR ASSEMBLY
UZ737	2	POST BRACE
UZ863	1	LEFT POST, 2B3306
UZ864	1	RIGHT POST, 2B3306
UZ890	1	LEFT BASE, 2B3306
UZ891	1	RIGHT BASE, 2B3306
UZ892	1	BACK BOTTOM BAR, 2B3306
UZ932	1	CROSSBAR
UZ953P1	2	BACKDROP BRACE
UZ967	1	BACKDROP RIGHT SIDE
UZ968	1	BACKDROP LEFT SIDE
3B2162	1	NET, SOCCER GOAL

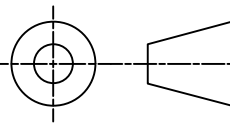

 THIRD ANGLE PROJECTION	 140 Pacific Drive Quakertown, Pa. 18951	
	DIMENSIONS ARE IN INCHES UNLESS OTHERWISE SPECIFIED	Approved By: Date:
This item is the exclusive property of KWIK GOAL LTD. Reproduction or duplication without the express written consent of KWIK GOAL LTD. is strictly forbidden.	Drawn By: CSpeck	Desc: 8' x 24' EVOLUTION 1.1 GOAL
	Date: 6/20/2003	
	Sheet: 4 of 4	
	Revision #: 10	
	Cad File: 2B3306.idw	