



ASSEMBLY INSTRUCTIONS FOR 9B25 21' BENCH WITH BACK

1. Unpack all parts and check for damage that may have occurred during shipping. If damage has occurred, notify trucking company immediately. Lay out all parts. Remove all cardboard and packaging immediately. Wet or damp packaging may damage contents.
2. Read through entire instruction before beginning assembly and installation.

NOTE: Components may be packaged in one or more additional boxes.

Parts

Bench Frame (4)
(Part# UZ469)

Frame Support (1)
(Part# UZ762)

Bench Plank (2)
(Part# UZ763)

Bench Hold Down (16)
(Part# UZ475)

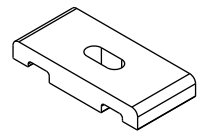
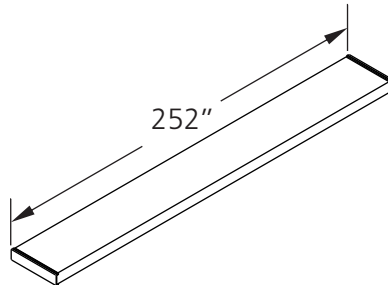
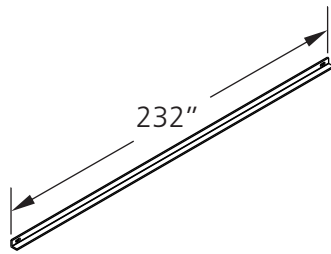
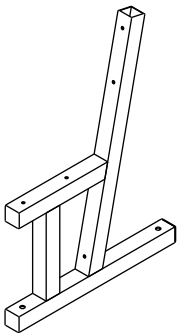

Hardware

- 5/16" x 3" Carriage Bolt (Part# TZ172) (16)
- 5/16" x 2-3/4" Carriage Bolt (Part# TZ191) (4)
- 5/16" Lock Nut (Part# TZ5) (20)
- 5/16" Flat Washer (Part# TZ4) (20)

Assembly Tools

Wrenches
1/2"

Ratchet with Socket
1/2"

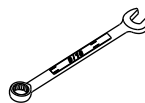

AND

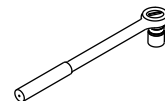

3. Center the first bench plank at location shown. Attach bench plank to each bench frame. Align bench hold down parallel with slot in bench plank, insert, and turn ninety degrees (quarter turn) to attach bench plank to bench frame. Do not overtighten bolts

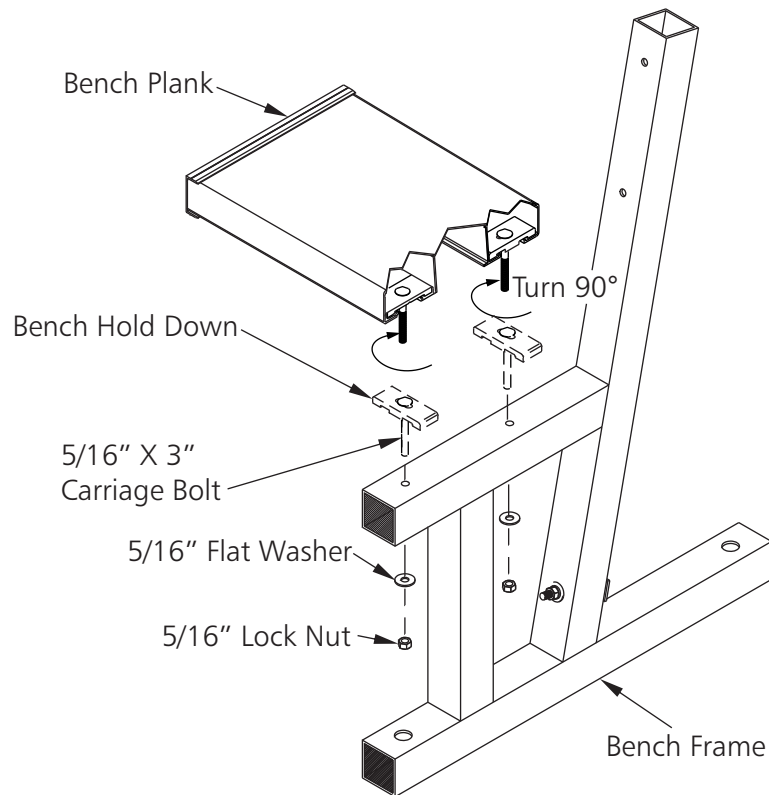

4. Center and attach second bench plank to bench frames, also attach frame support to bench frame. Do not overtighten bolts.

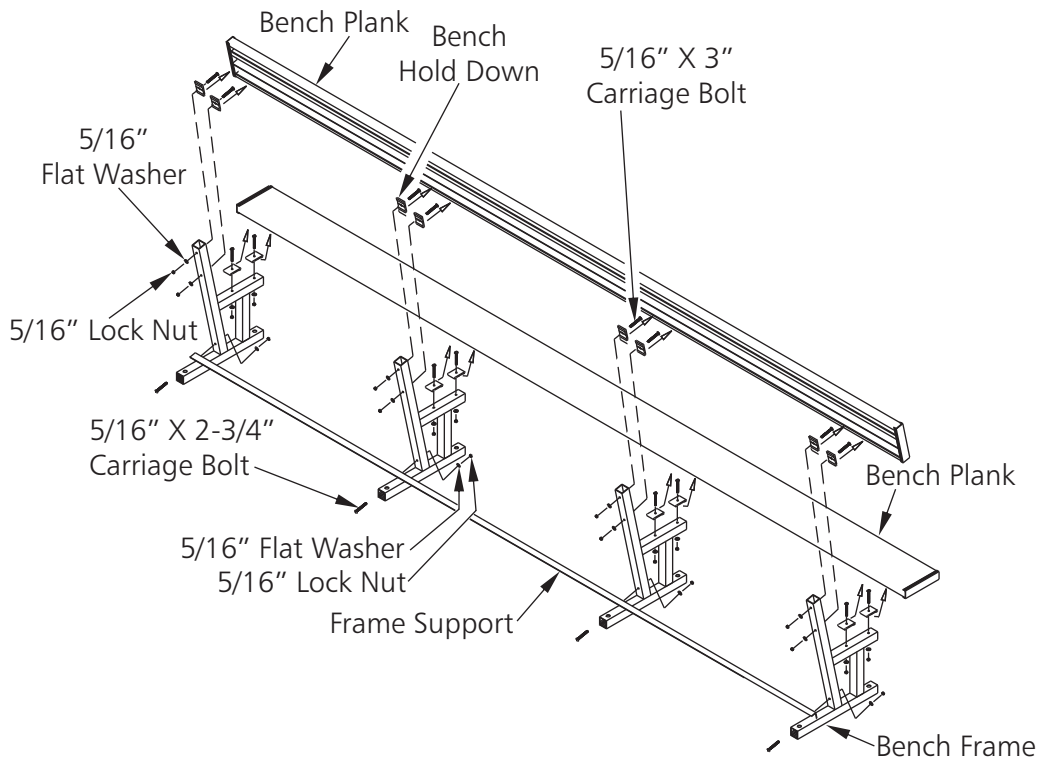

Go to kwikgoal.com for additional product information.