

FRONT VIEW

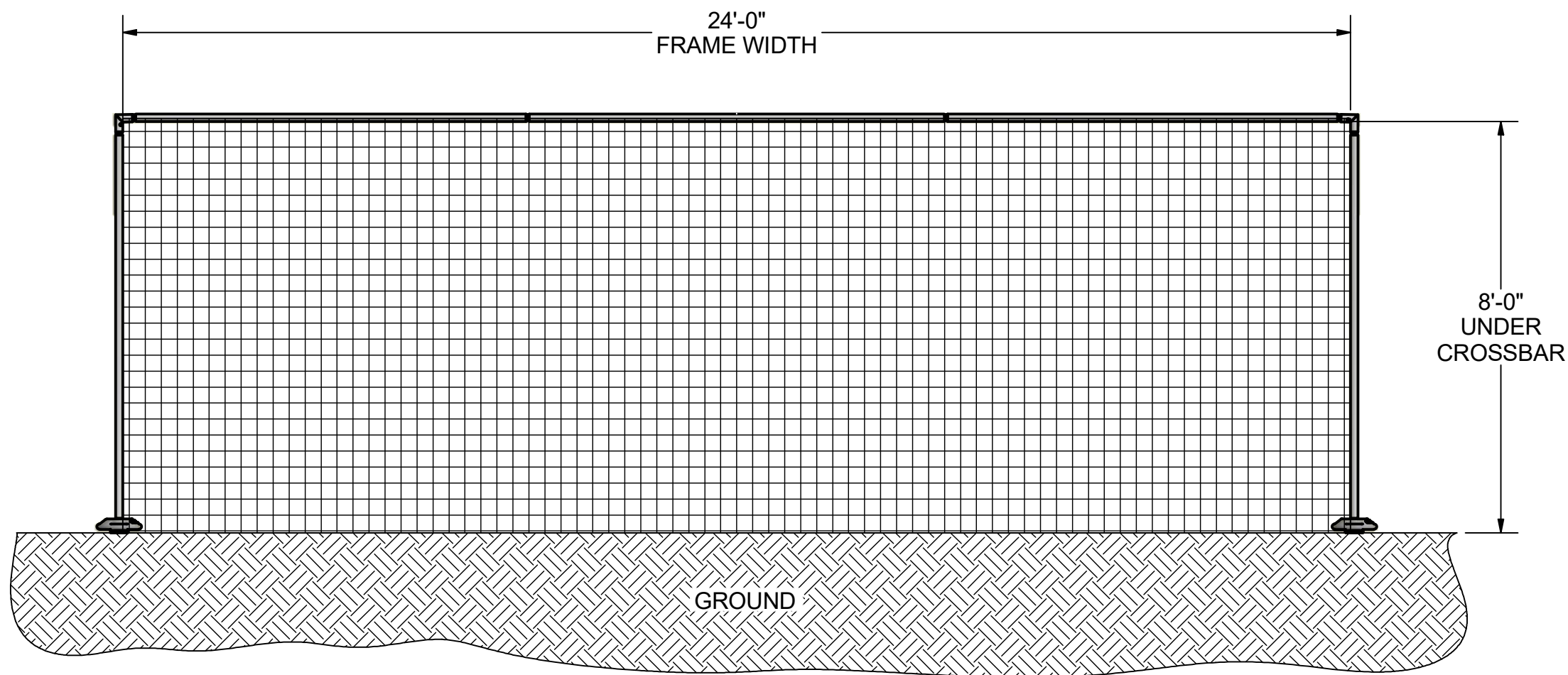

SIDE VIEW

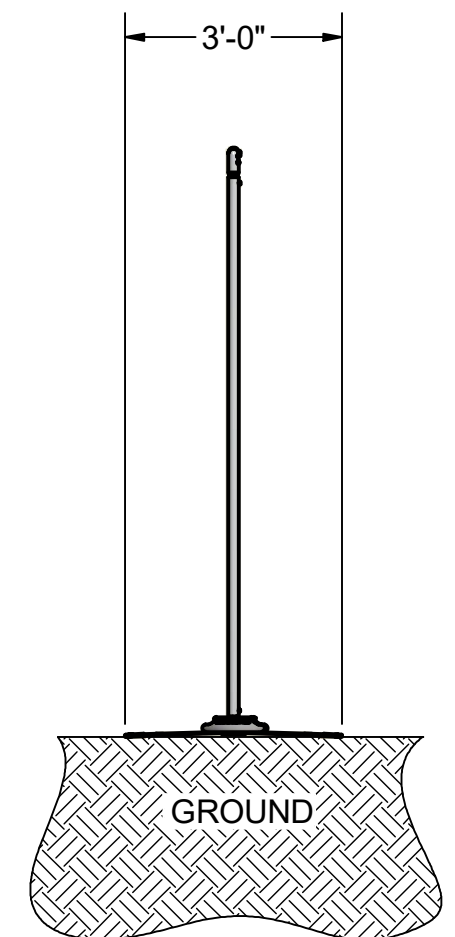

NOTES:

- 1) ALUMINUM FRAME
- 2) FINISH: WHITE POWDER COATED
- 3) INCLUDED:
 - 3 mm, WHITE NET
 - 2 WEIGHTS
 - CARRY BAG
- 4) ASSEMBLED WEIGHT: 118 LBS.

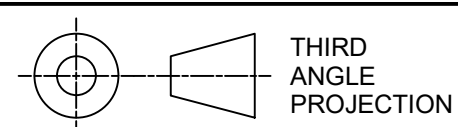

THIRD
ANGLE
PROJECTION



140 Pacific Drive
Quakertown,
Pa. 18951

DIMENSIONS ARE IN INCHES
UNLESS OTHERWISE SPECIFIED

Approved By: Willenbecher
Date: 9/7/2016

Part #:
WC-240AS

This item is the **confidential**
property of **KWIK GOAL LTD.**
Reproduction or duplication
without the express written
consent of **KWIK GOAL LTD.**
is **strictly forbidden.**

Drawn By: cspeck
Date: 8/17/2016
Sheet: 1 of 4
Revision #: 1
Cad File: WC-240AS.idw

Desc:
NXT TRAINING FRAME
8' X 24'

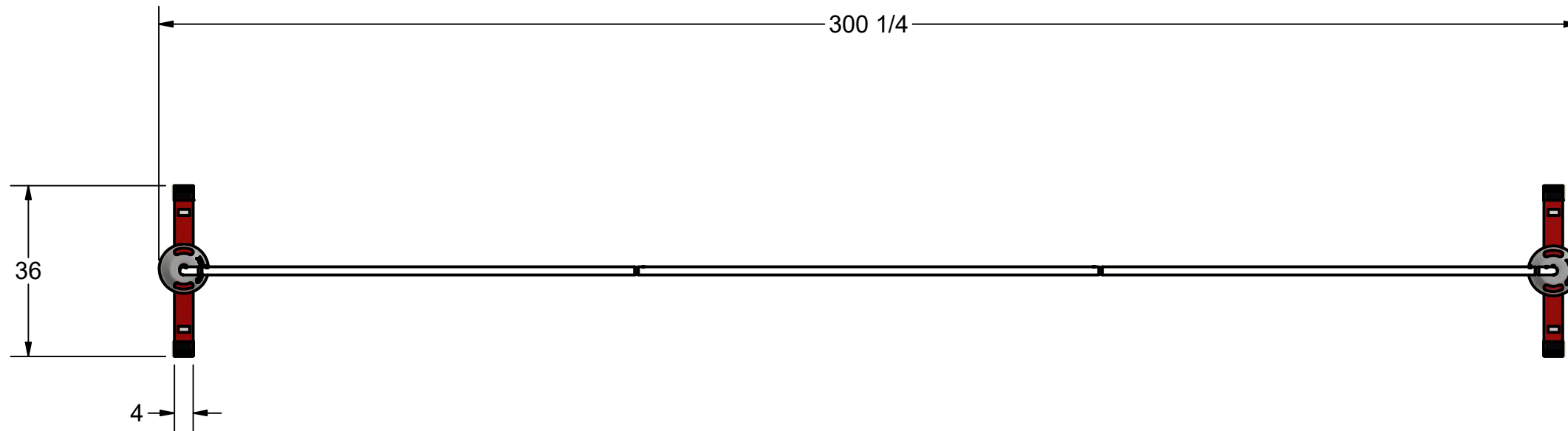

OVERHEAD VIEW

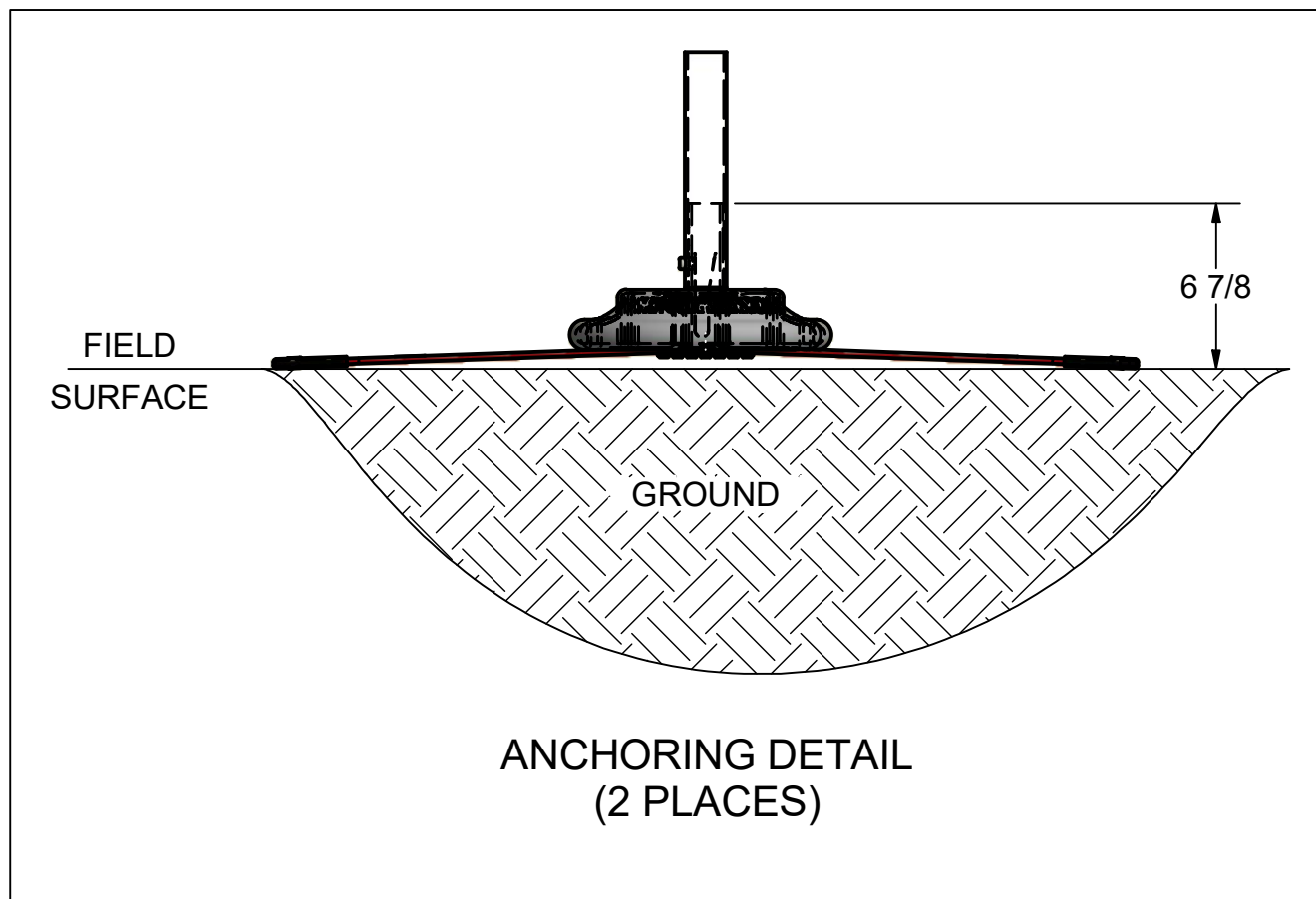

NOTES:

- 1) DIMENSIONS ARE FOR PLANNING PURPOSES. INSTALLATION MUST BE IN ACCORDANCE WITH INSTALLATION INSTRUCTIONS.

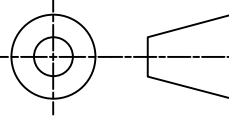

 THIRD ANGLE PROJECTION	 KWIKGOAL [®] 140 Pacific Drive Quakertown, Pa. 18951	
	DIMENSIONS ARE IN INCHES UNLESS OTHERWISE SPECIFIED	Approved By: Willenbecher Date: 9/7/2016
This item is the confidential property of KWIK GOAL LTD. Reproduction or duplication without the express written consent of KWIK GOAL LTD. is strictly forbidden.	Drawn By: cspeck Date: 8/17/2016	Desc: NXT TRAINING FRAME 8' X 24'
	Sheet: 2 of 4 Revision #: 1	
	Cad File: WC-240AS.idw	

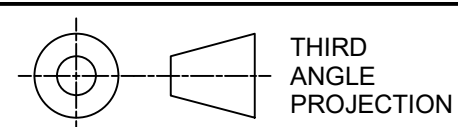
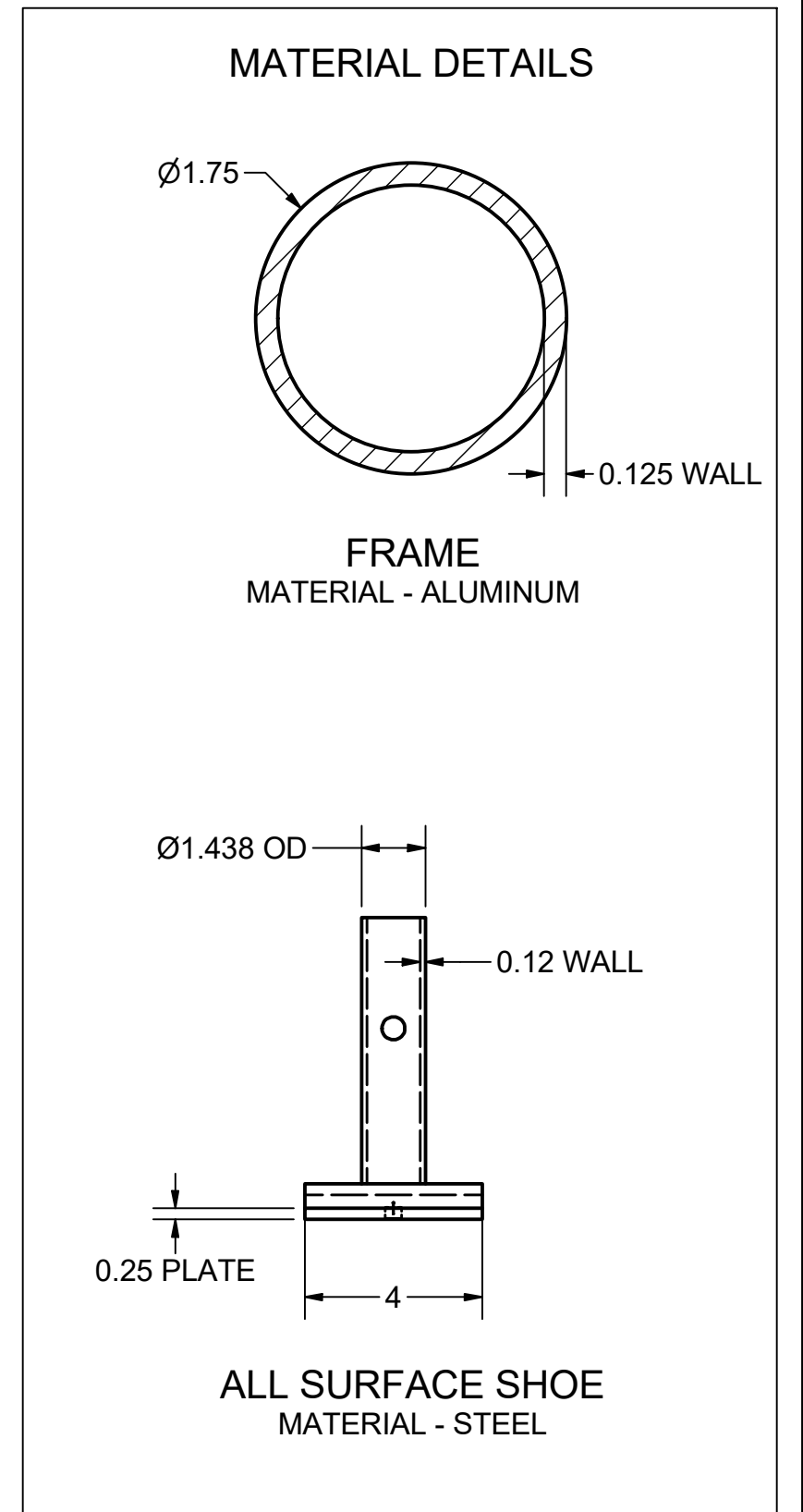
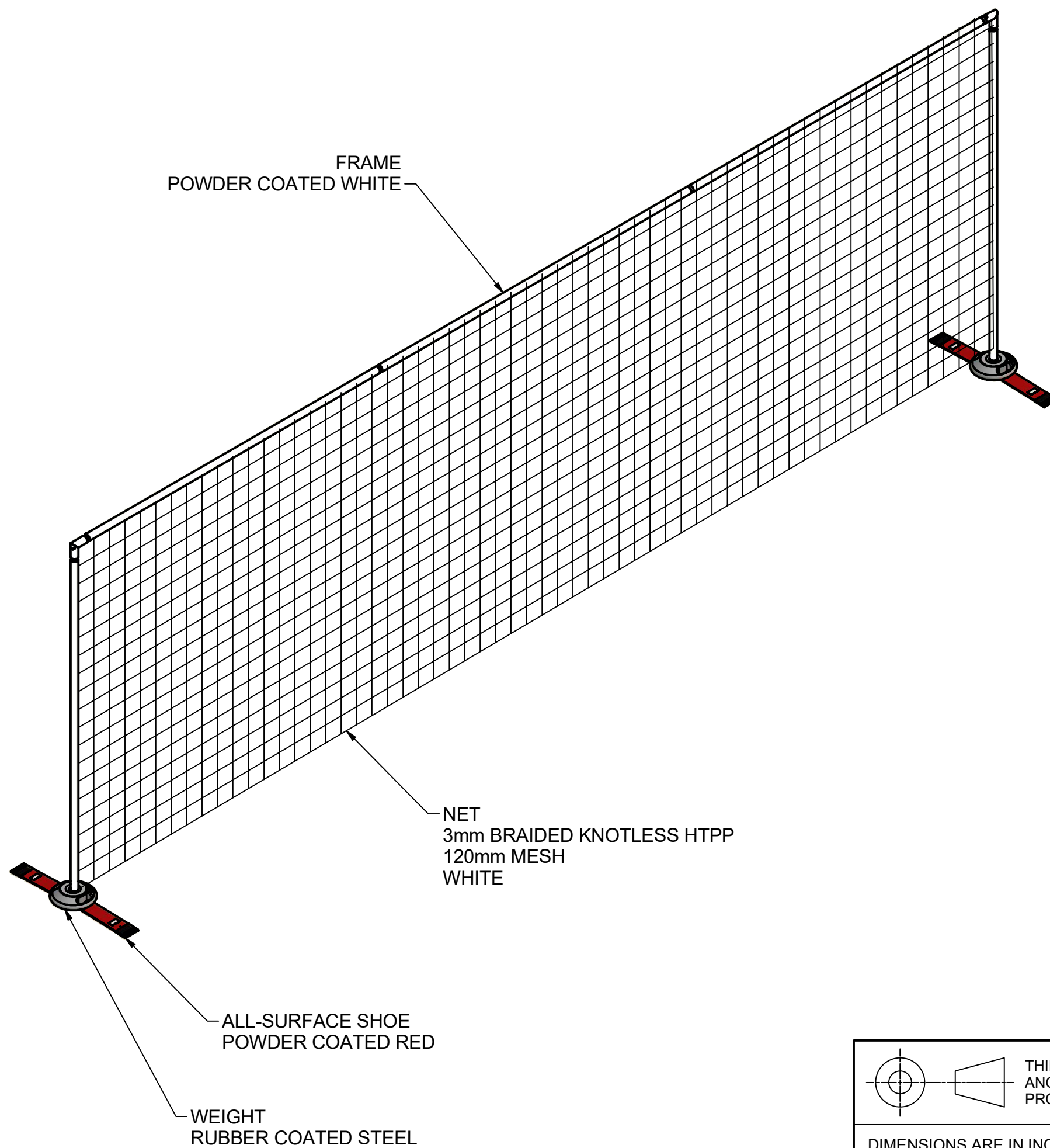

KWIKGOAL® 140 Pacific Drive
Quakertown,
Pa. 18951

DIMENSIONS ARE IN INCHES
UNLESS OTHERWISE SPECIFIED

Approved By: Willenbecher
Date: 9/7/2016

Part #:
WC-240AS

This item is the **confidential**
property of **KWIK GOAL LTD.**
Reproduction or duplication
without the express written
consent of **KWIK GOAL LTD.**
is **strictly forbidden.**

Drawn By: cspeck
Date: 8/17/2016
Sheet: 3 of 4
Revision #: 1
Cad File: WC-240AS.idw

Desc:
NXT TRAINING FRAME
8' X 24'

PARTS LIST		
PART#	QTY	DESCRIPTION
UZ129	2	ALL-SURFACE SHOE, NXT TRAINING FRAME
UZ1557	2	POST
UZ1554	2	CROSSBAR CORNER 92°
UZ1549	2	CROSSBAR SWAGE
WZ1003	1	CROSSBAR
WC-24GAW	1	NET, NXT TRAINING FRAME
VZ760	2	BASE WEIGHT

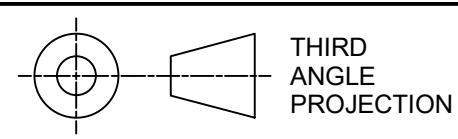
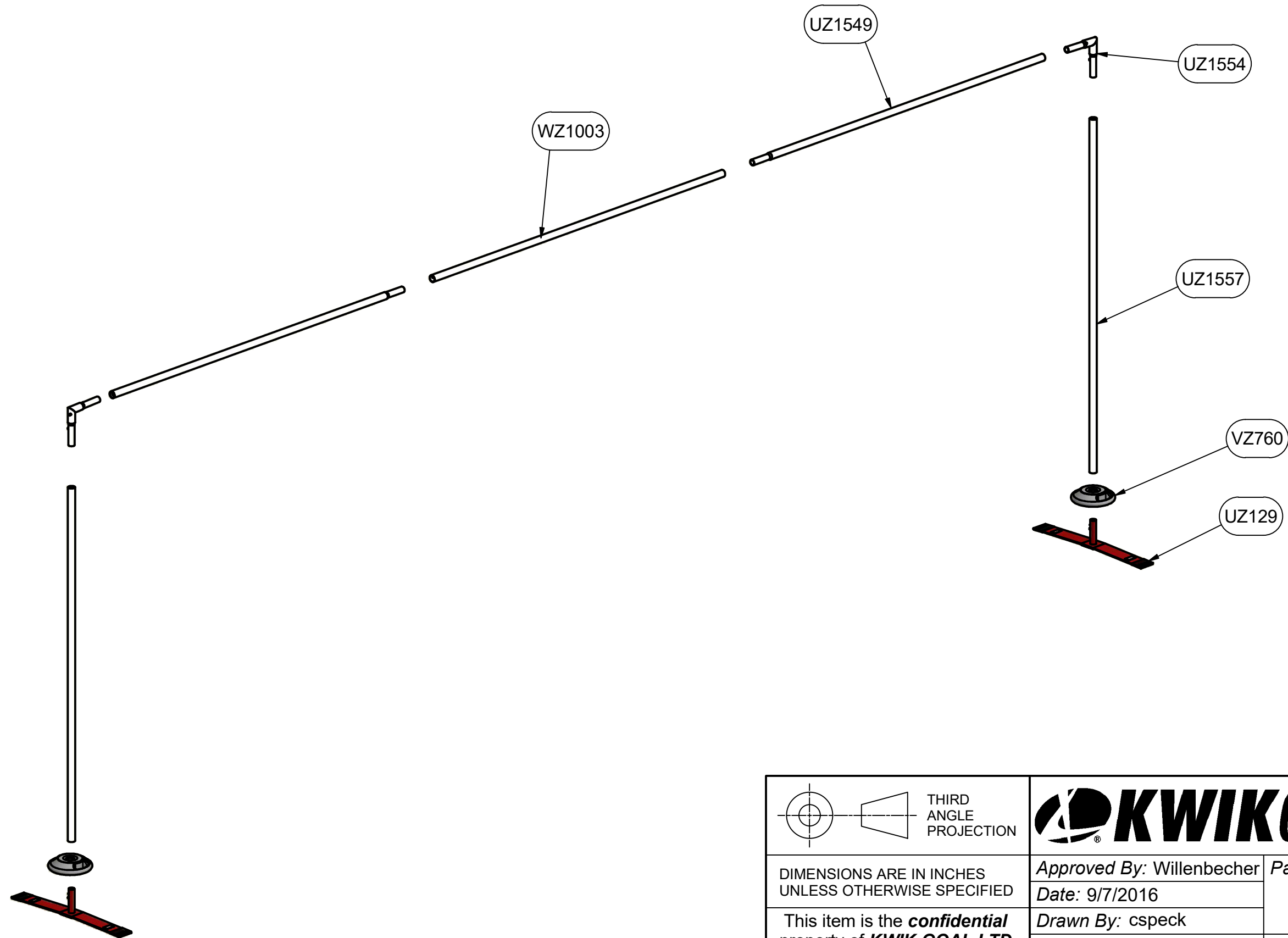

KWIK GOAL® 140 Pacific Drive
Quakertown, Pa. 18951

DIMENSIONS ARE IN INCHES
UNLESS OTHERWISE SPECIFIED

Approved By: Willenbecher
Date: 9/7/2016

Part #: **WC-240AS**

This item is the **confidential** property of **KWIK GOAL LTD.** Reproduction or duplication **without** the express written consent of **KWIK GOAL LTD.** is **strictly forbidden.**

Drawn By: cspeck
Date: 8/17/2016
Sheet: 4 of 4
Revision #: 1
Cad File: WC-240AS.idw

Desc: NXT TRAINING FRAME
8' X 24'